

QUINTA VÁLIDA

SÁBADO 7 DE DICIEMBRE 2019

LIBRO DE RUTA



3 ESPECIALES DE VELOCIDAD
2 Tramos en el día + 1 Tramo en la noche



UNIVERSIDAD REGIONAL AUTÓNOMA DE LOS ANDES
UNIANDES | TO THE HEIGHT OF YOUR DREAMS

Más información en: www.tac.ec



ITINERARIO

Quinta Válida:
**Campeonato de Trepada de
 Montaña D'Campo 2019**

GRAN PREMIO D'CAMPO - QUINTA VÁLIDA CAMPEONATO DE TREPADA DE MONTAÑA TAC 2019								
SABADO 7 DE DICIEMBRE 2019								
PARQUE DE PASA	INGRESO CATEGORIAS RC2, N4, UTV TURBO INGRESO CATEGORIAS T1 Y T2 INGRESO CATEGORIAS T3 Y T4 INGRESO CATEGORIAS TT Y UTV 1				11:00	12:00		
	REVISION MECANICA ADMINISTRATIVA Y DE SEGURIDAD				11:00:00	14:00		
	REUNION DE PILOTOS Y ENCOLUMNAMIENTO				14:30	14:45		
		Km ENLACE	Km PRIME	Km TOTAL	TIEMPO IDEAL	HORA INICIO	PASO 1ER AUTO	TIEMPO MAXIMO
E 1	PARQUE DE PASA - AGUAJAN	4,9		4,9	0:20:00	15:00:00	15:20:00	
TC1	AGUAJAN - MOGATO - SIGUITAG		6,6	6,60	0:05:00	15:20:00	15:25:00	0:10:00
E 2	SIGUITAG - PASA - AGUAJAN	9,2		9,2	1:00:00	15:25:00	16:25:00	
TC2	AGUAJAN - MOGATO - SIGUITAG		6,6	6,60	0:05:00	16:25:00	16:30:00	0:10:00
E 2	SIGUITAG - PASA - AGUAJAN - LA LIRIA	25,4		25,4	1:00:00	16:30:00	17:30:00	
REAGRUPAMIENTO CENTRO CULTURAL LA LIRIA						17:30:00	18:00:00	
E 3	LA LIRIA - PINLLO	4,1		10,7	0:30:00	18:30:00	19:00:00	
TC3	PINLLO - PARQUE DE LA FAMILIA		4,1	14,8	0:05:00	19:00:00	19:05:00	0:10:00
PREMIACION CENTRO CULTURAL LA LIRIA						21:30:00		

43,6	17,3	60,9
72%	28%	100%



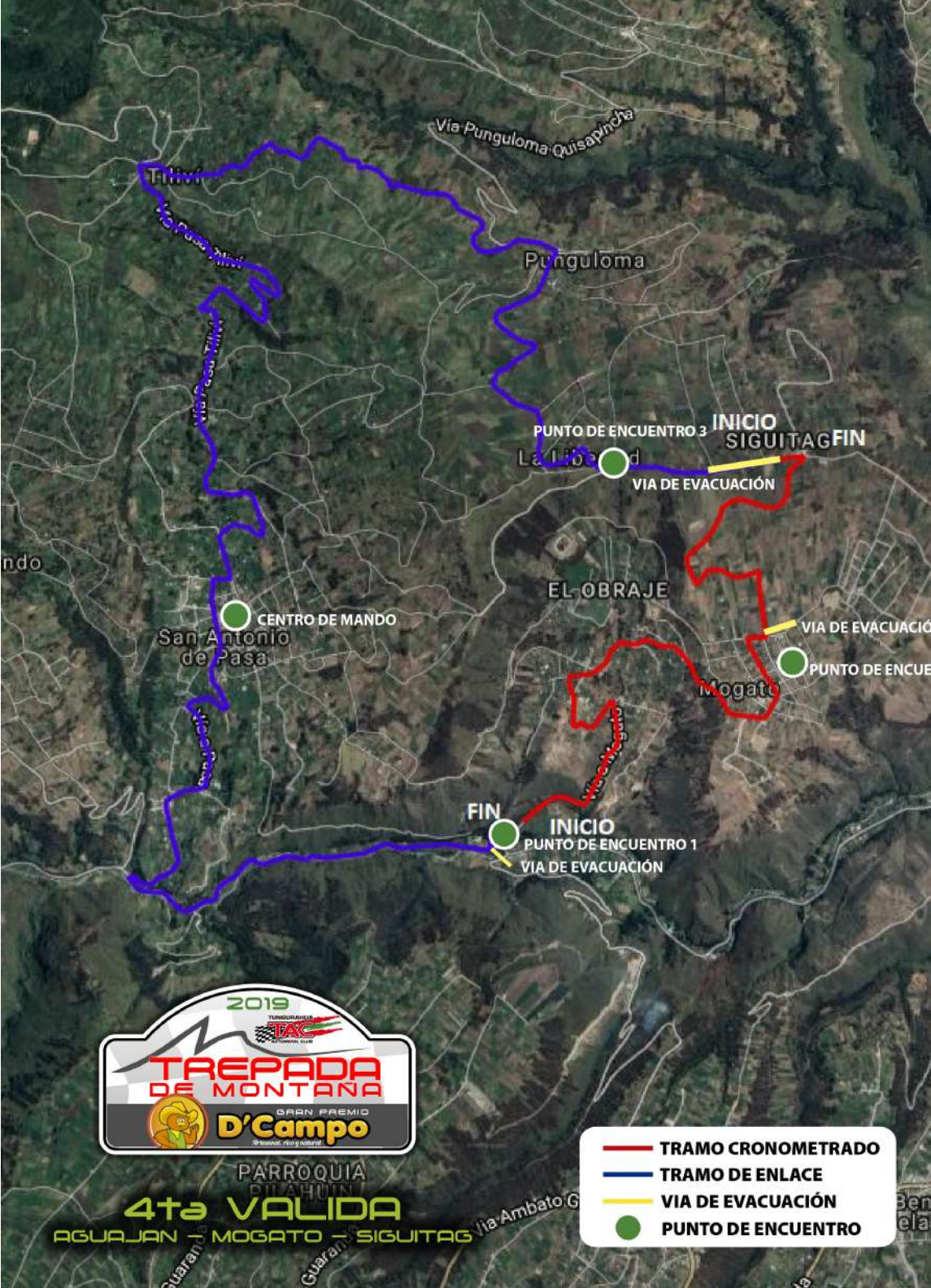

















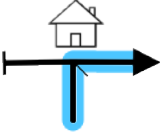
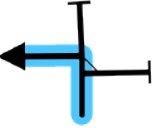

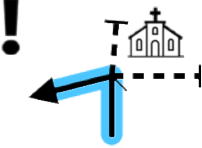
2019
 TUNGURAHUA
 TAX
TREPADA DE MONTAÑA
 GRAN PREMIO
D'Campo
 "Paseo, plus y natural"

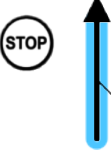



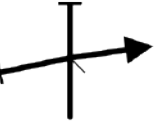

PARROQUIA
 BILAHUANI
4ta VALIDA
 AGUAJAN - MOGATO - SIGUITAG

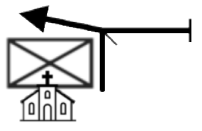
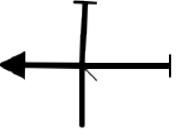
- TRAMO CRONOMETRADO
- TRAMO DE ENLACE
- VIA DE EVACUACIÓN
- PUNTO DE ENCUENTRO

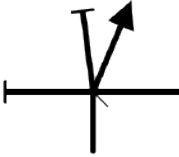
PAGE 1	P1-2: AGUAJAN - MOGATO -SIGÚITAG	KM TOTAL : 6.2
<p>0,00</p> <p>1 0,00</p>		<p>INICIO PRIME JUNTO A SEÑAL DE TRÁNSITO</p>
<p>1,10</p> <p>2 1,10</p>		
<p>1,39</p> <p>3 0,29</p>		
<p>1,75</p> <p>4 0,36</p>		
<p>2,17</p> <p>5 0,42</p>		
<p>2,63</p> <p>6 0,46</p>		
<p>3,07</p> <p>7 0,44</p>		<p>EN LOMO</p>
<p>PROXIMA NOTA PROCH NOTE NEXT NOTE</p>	<p>0,33</p>	

PAGE 2	P1-2: AGUAJAN - MOGATO -SIGÜITAG	KM TOTAL : 6.2
<p>3,40</p> <p>8 0,33</p>		<p>PARQUE DE MOGATO</p>
<p>3,84</p> <p>9 0,44</p>		
<p>3,95</p> <p>10 0,11</p>		
<p>4,34</p> <p>11 0,39</p>		
<p>6,10</p> <p>12 1,76</p>		
<p>6,20</p> <p>13 0,10</p>		<p>MESA DE CONTROL</p>
<p>6 Km</p>	<p>13 Waypoints</p>	<p>6 Km Fuel Range</p>
<p>Start: 001°16.785'S 078°42.930'W</p>		<p>Finish: 001°15.582'S 078°42.057'W</p>

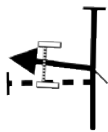



PAGE 1	E2 SIGÜITAG - PASA - AGUAJAN	KM TOTAL : 10.08
<p>0,00</p> <p>1 0,00</p>		<p>INICIO ENLACE</p>
<p>1,13</p> <p>2 1,13</p>		<p>BAJA</p>
<p>2,58</p> <p>3 1,45</p>		<p>A PASA</p>
<p>4,38</p> <p>4 1,80</p>		<p>ANGOSTO ADOQUIN</p>
<p>4,58</p> <p>5 0,20</p>		<p>PASA MERCADO</p>
<p>4,79</p> <p>6 0,21</p>		<p>-INICIO ENLACE 1 -ZONA DE REVISIÓN MECÁNICA -PARQUE DE PASA</p>
<p>4,93</p> <p>7 0,14</p>		<p>VIA A AMBATO</p>
<p>PROXIMA NOTA PROCH NOTE NEXT NOTE</p>	<p>0,20</p>	

PAGE 2	E2 SIGÜITAG - PASA - AGUAJAN	KM TOTAL : 10.08
<p data-bbox="258 129 423 211">5,13</p> <p data-bbox="235 284 264 316">8</p> <p data-bbox="329 267 441 316">0,20</p>		
<p data-bbox="258 324 423 406">7,33</p> <p data-bbox="235 479 264 511">9</p> <p data-bbox="329 462 441 511">2,20</p>		<p data-bbox="729 324 899 349">VIA A AMBATO</p>
<p data-bbox="258 519 423 600">8,31</p> <p data-bbox="235 673 264 706">10</p> <p data-bbox="329 657 441 706">0,98</p>		
<p data-bbox="258 714 423 795">8,65</p> <p data-bbox="235 868 264 901">11</p> <p data-bbox="329 852 441 901">0,34</p>		
<p data-bbox="258 909 423 990">9,71</p> <p data-bbox="235 1063 264 1096">12</p> <p data-bbox="329 1047 441 1096">1,06</p>		
<p data-bbox="258 1104 423 1185">9,79</p> <p data-bbox="235 1258 264 1291">13</p> <p data-bbox="329 1242 441 1291">0,08</p>		<p data-bbox="729 1096 964 1144">DESVIO SUBE LETRERO RED VIAL</p>
<p data-bbox="235 1291 446 1372">10,04</p> <p data-bbox="235 1437 264 1469">14</p> <p data-bbox="329 1421 441 1469">0,25</p>		<p data-bbox="729 1291 911 1315">FIN DE ENLACE</p>

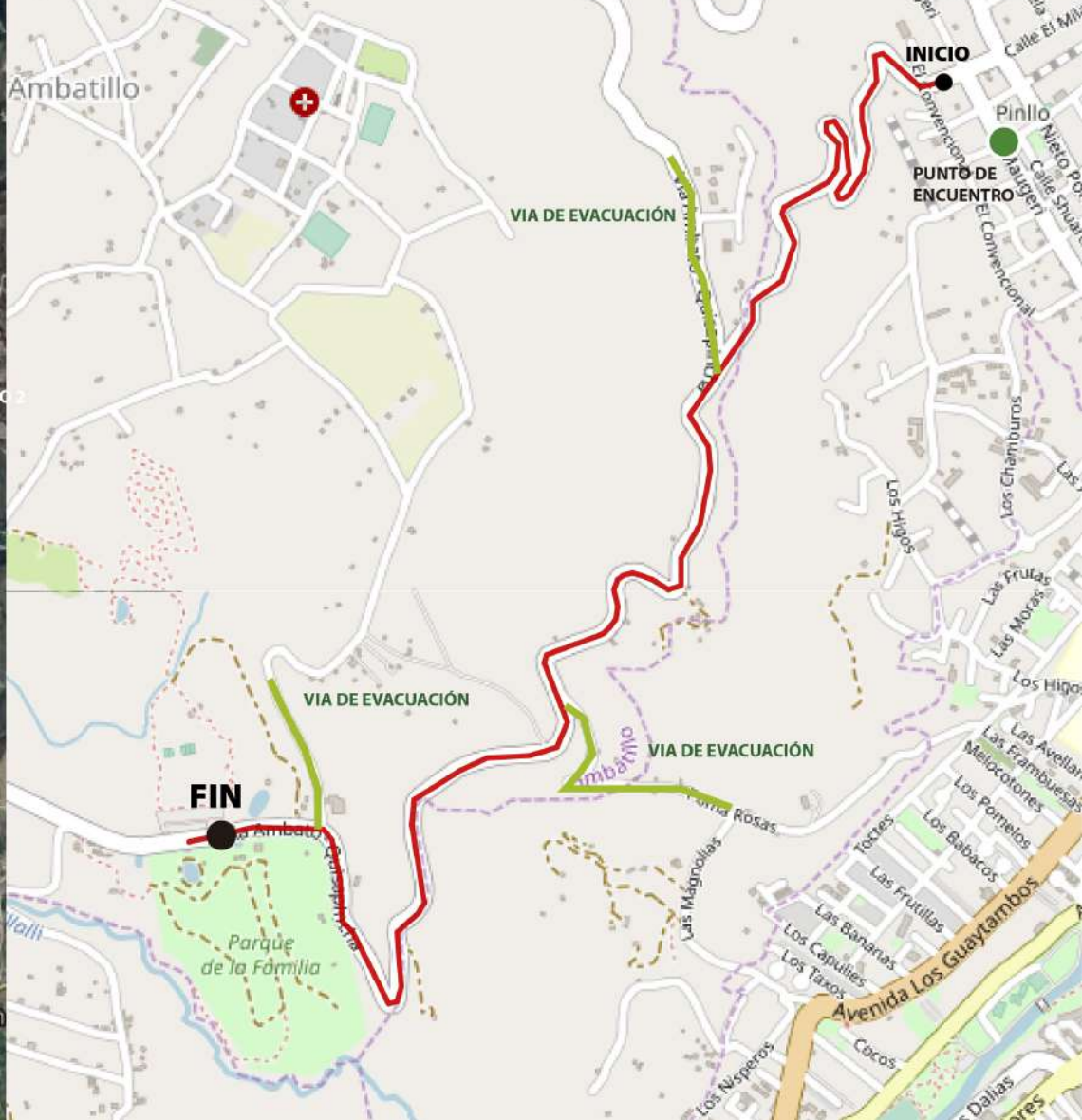

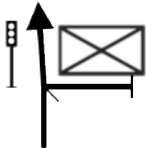



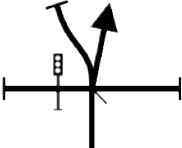

4ta VALIDA PINILLO - PARQUE DE LA FAMILIA



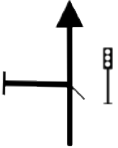
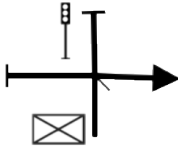

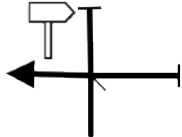

PAGE 1	E3 LA LIRIA - PINLLO	KM TOTAL : 4.08
<p>0,00</p> <p>1 0,00</p>		<p>INICIO ENLACE SALIDA LA LIRIA HACIA ATOCHA</p>
<p>0,13</p> <p>2 0,13</p>		<p>PARQUE</p>
<p>0,53</p> <p>3 0,39</p>		
<p>0,85</p> <p>4 0,32</p>		
<p>1,14</p> <p>5 0,29</p>		
<p>1,27</p> <p>6 0,13</p>		<p>ANGOSTO IESS</p>
<p>1,44</p> <p>7 0,17</p>		<p>SEGUIR POR AV. LOS GUAYTAMBOS</p>

PROXIMA NOTA
PROCH NOTE
NEXT NOTE

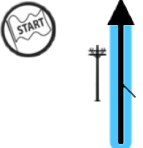

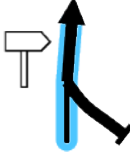
0,45

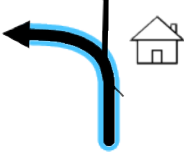
PAGE 2	E3 LA LIRIA - PINLLO	KM TOTAL : 4.08
<p>1,89</p> <p>8 0,45</p>		
<p>2,07</p> <p>9 0,19</p>		<p>PASA SUPERMAXI DESVIO SUBE</p>
<p>2,14</p> <p>10 0,06</p>		
<p>3,08</p> <p>11 0,94</p>		<p>VIA AMBATO - QUISAPINCHA</p>
<p>3,33</p> <p>12 0,25</p>		<p>VIA A QUISAPINCHA</p>
<p>4,02</p> <p>13 0,69</p>	<p>!</p> 	<p>DESVIO CALLE MILANESIO</p>
<p>4,08</p> <p>14 0,06</p>		<p>ENTRE CASAS 2do. POSTE FIN DE ENLACE</p>

PAGE 1	TC 3 PINLLO -PARQUE DE LA FAMILIA	KM TOTAL : 4.28
<p>0,00</p> <p>1 0,00</p>		<p>INICIO CALLE MILANESIO 2do. POSTE</p>
<p>0,16</p> <p>2 0,16</p>		
<p>0,52</p> <p>3 0,36</p>		
<p>1,50</p> <p>4 0,98</p>		<p>LETRERO BLANCO VIA AMBATO - QUISAPINCHA</p>
<p>2,54</p> <p>5 1,04</p>		
<p>3,49</p> <p>6 0,95</p>		<p>SUBE CERCA DE PALOS</p>
<p>3,97</p> <p>7 0,48</p>		<p>PALAMA</p>

PROXIMA NOTA
PROCH NOTE
NEXT NOTE

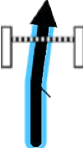
0,21

PAGE 2	TC 3 PINLLO -PARQUE DE LA FAMILIA	KM TOTAL : 4.28
<p>4,18</p> <p>8 0,21</p>	 	<p>ROTULO AMARILLO FIN DE PRIME ANTES DE PASO PEATONAL</p>
<p>4,28</p> <p>9 0,10</p>		<p>STOP</p> <p>MESA DE CONTROL</p>
<p>4 Km</p>	<p>9 Waypoints</p>	<p>4 Km Fuel Range</p>
<p>Start: 001°13.856'S 078°38.583'W</p>		<p>Finish: 001°14.787'S 078°39.502'W</p>

MÉDICO: Dra. Karina Salazar

SOSES

**EN CASO DE NECESITAR AYUDA MEDICA INMEDIATA
COLOQUE ESTA HOJA EN UN LUGAR VISIBLE DE SU AUTO
O MUESTRELA AL SIGUIENTE PARTICIPANTE**

OK

SI NO NECESITA AYUDA POR FAVOR
COLOQUE SU AUTO EN UN SITIO SEGURO Y
COLOQUE ESTA HOJA EN UN LUGAR VISIBLE DE SU AUTO
Y UTILICE LAS BANDERAS DE PRECAUCIÓN

ABANDONO

NOMBRE: _____

No. DE AUTO: _____

NUMERO DE TC

REFERENCIA:

CAUSA DE ABANDONO:

FIRMA DEL COMPETIDOR

BARREDORA

FORMULARIO DE SOLICITUD

..... , de diciembre de 2019

Señores.
COMISARIOS DEPORTIVOS
Presente.-

De mis consideraciones

Yo,..... ,auto No:

Solicito a usted (s)

.....
.....
.....
.....
.....
.....
.....
.....
.....
.....
.....
.....
.....
.....
.....
.....
.....
.....

Atentamente,

Piloto:
c.i.:

Concurrente:
c.i.:

Recibido por:

Fecha:

Hora: